



# Flap Barrier

## FB-TL-2200



### Specification

Power Requirements : AC100~120V/200~240V,50/60Hz

Working Temperature : -28°C to 60°C

Working Humidity : 5%~80%

Protection level : IP44

Working Environment : Indoor/outdoor (if sheltered)

RFID : Maximum 35/ minute

Fingerprint : Maximum 25/ minute

Face : Maximum 11/ minute

Vein : Maximum 23/ minute

Lane width(mm) : 550

Input : Dry Contact

Unlock Time : 0.2 sec

Dimensions(mm) : L=1200,W=280,H=980

Net Weight(kg) : 100

LED Indicator : Yes

Cabinet Material : SUS304 Stainless Steel

Lid Material : SUS304 Stainless Steel

Barrier Material : Acrylic

Barrier Movement : Retracting

Emergency Mode : Yes

Security Level : Medium

MCBF : 2 million

#### Dimensions

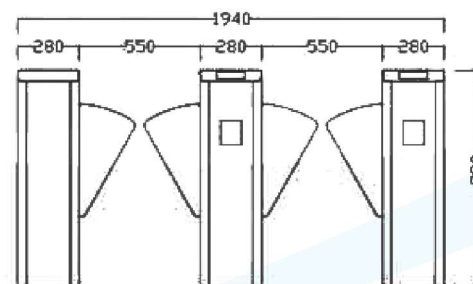
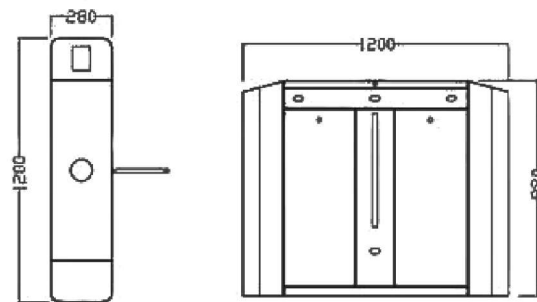

Disclaimer: Brief specifications are mentioned here. Specifications may change without prior notice. Customers are advised to check with us before purchase. Actual product may differ slightly to that depicted for ongoing product development